

CHAMBERLAIN®

GRIFCO

Mini Receiver Card (MRC2) Manual

Rev. 808021

START BY READING THESE IMPORTANT SAFETY RULES

WARNING: Important safety instructions. It is important for the safety of persons to follow all instructions. Save these instructions.



Disconnect power before installation. Operator must be properly grounded and connected in accordance with local electrical codes.



Do not allow children to play with door controls. Keep transmitters away from children;



All electrical connections must be made by a qualified person. Only Qualified electricians may open and work within the controller enclosure.



Activate operator only when the door is in full view, free of obstructions and operator is properly adjusted.

INTRODUCTION

This Mini Receiver Card (MRC2) is compatible with Chamberlain Rolling or Billion code transmitters. The first transmitter learnt will set the receiver to Rolling or Billion code operation. To change from Rolling to Billion code or vice versa perform a bulk erase and learn the desired transmitter.

INSTALLATION



WARNING: Take extreme care to ensure pins are correctly aligned. Failure to follow this warning could damage the product

While power is OFF, plug the receiver card into the main control board (MCB),
Ensuring that the white plastic posts line up with the holes of the MRC line up with the holes in the main circuit board.

NOTE: DO NOT remove the white plastic posts provided

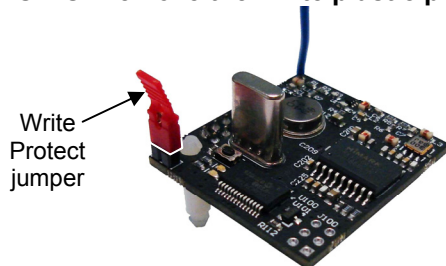

REMOVE jumper from the receiver card and turn power on.

You are now ready to learn your transmitters.

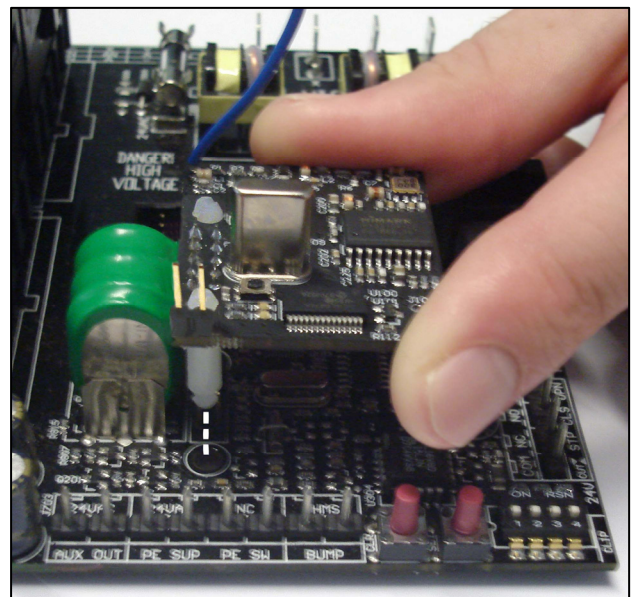

OPERATION

The *Controller Front Panel* instructions on this page are only suitable for the MCB-MK3 (black MCB). These operators can be recognised by the silver sticker (as shown below) positioned on the rear of the operator.

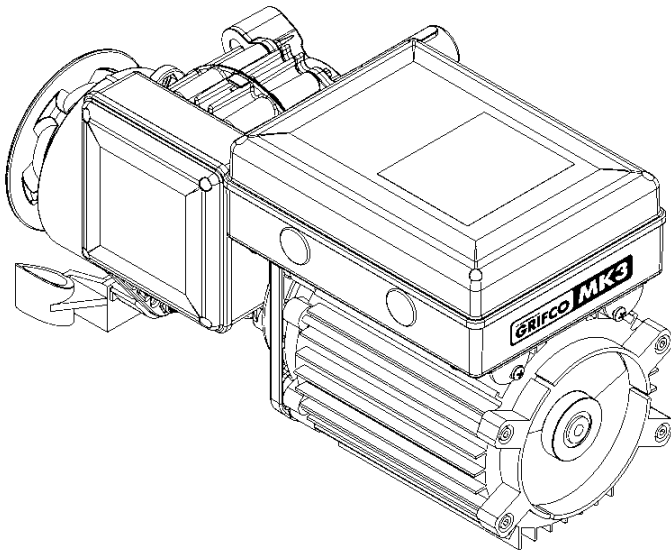

If your operator does not have the silver sticker it is probable that it is a MCB-MK1 or MK2. For MCB-MK1 or MK2 (green or blue MCBs) the *Onboard Button* instructions over the page should be followed.

Controller Front Panel Learn

(Bulk learn via Maestro Controller)

To learn a transmitter installed in a MCB-MK3 (black MCB) follow the *Front Panel learn instructions* below.

NOTE: Ensure that the receiver card write protect jumper is removed before turning on power. If not, turn off power, remove jumper and then turn power on.

- Press and hold SET, then whilst holding...
- Press STOP 5 times (green status light will light then continue flashing, indicating learn mode)
- Press the desired TRANSMITTER BUTTON to learn (orange limit light will flash fast after each transmitter is successfully learnt)
- When learning additional transmitters continue to press desired channel button until all required transmitters are learnt
- Press STOP to exit learn mode

NOTE: Operator will not respond if limits are not set.

If an Expansion Board is connected to the MCB, the operator will not respond for 30 seconds after the last Front Panel button press.

You should now replace the Write Protect jumper to secure your operator.

Controller Front Panel Erase

(Bulk erase via Maestro Controller)

NOTE: Ensure that the receiver card write protect jumper is removed before turning on power. If not, turn off power, remove jumper and then turn power on.

WARNING: THIS BULK ERASE PROCEDURE REMOVES ALL TRANSMITTERS FROM THE RECEIVER

- Press and hold the SET, then whilst holding...
- Press the STOP button 4 times, holding on the fourth press for 5 seconds (orange light will flash to indicate erase request, then green light will flash to indicate completion)

You should now replace the Write Protect jumper to secure your operator.

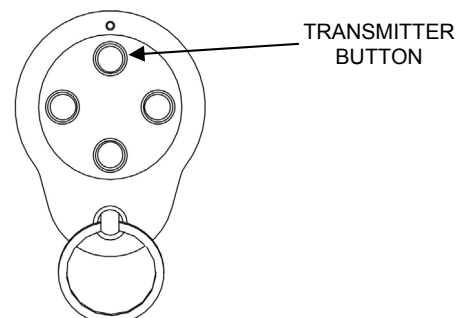
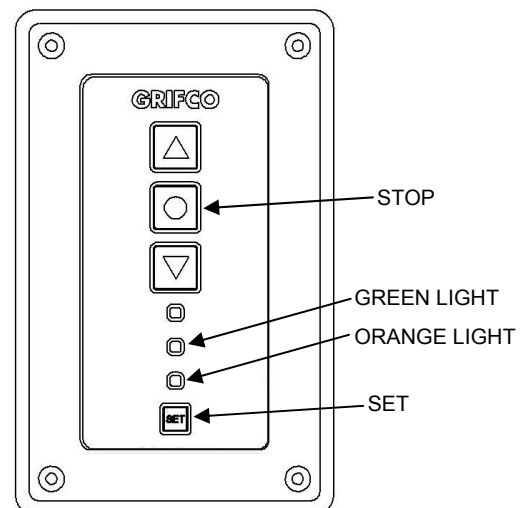

For MCB-MK1 or MK2 (green or blue MCBs) the below instructions should be followed.



WARNING

Only press the learn button with a non-conductive tool
Failure to follow this warning could damage the product

Onboard Button Learn

(Single Learn via receiver card mini learn button)

NOTE: Ensure that the receiver card write protect jumper is removed before turning on power. If not, turn off power, remove jumper and then turn power on.

- Press the LEARN BUTTON on the receiver card, red light will come on
- Press desired TRANSMITTER BUTTON, green light will flash

Repeat process until all required transmitters are learnt

NOTE: Operator will not respond if limits are not set

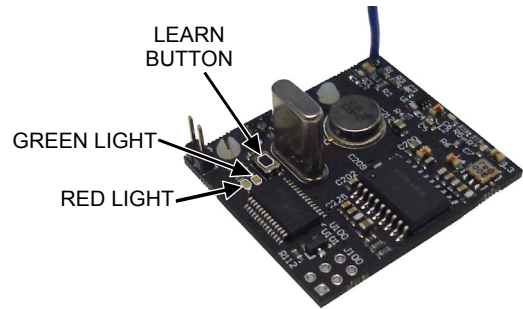

Onboard Button Erase

(Bulk Erase via receiver card mini learnt button)

NOTE: Ensure that the receiver card write protect jumper is removed before turning on power. If not, turn off power, remove jumper and then turn power on.

WARNING: THIS BULK ERASE PROCEDURE REMOVES ALL TRANSMITTERS FROM THE RECEIVER

- Press and hold the LEARN BUTTON on the receiver card until red light goes out (approximately 10 seconds)

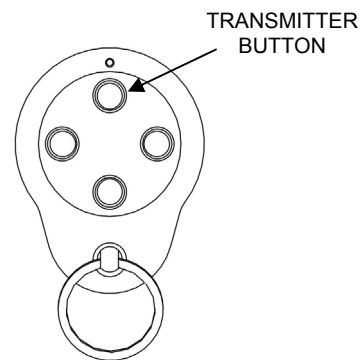

RANGE

The operating range will depend largely on the surrounding environment in terms of the structure that surrounds the Receiver Card and also other radio frequencies used in the area. Before learning bulk quantities of transmitters, ensure that the performance is satisfactory. Some installations require that the aerial wire protrudes out of the main control enclosure base through a small hole (approx. 2-3mm diameter).

LIGHT STATUS CHART

RED Light	GREEN Light	STATUS
OFF	ON	Transmitter has just been learnt
Flashing Slow	ON	Receiver has detected a signal from a learnt transmitter
Flashing Slow	OFF	Receiver has detected a signal from a transmitter not learnt
Flashing Fast		Receiver has detected a signal from a transmitter, but is in Write Protect mode

CHAMBERLAIN 24 MONTH LIMITED WARRANTY

(Excluding electric motors)

Chamberlain Australia Pty Limited / Chamberlain New Zealand Limited (**Seller**) warrants to the original purchaser of the Grifco product (**Unit**) that it is free from defects in material and/or workmanship for a period of 24 months from the date of first purchase from the Seller.

If, during the limited warranty period, the Unit fails due to defects in materials or workmanship Chamberlain will, provided the defective part or Unit is returned freight and insurance prepaid and well packaged to the nearest Chamberlain office, undertake to repair or, at its option, replace any defective part or Unit and return it to the Buyer at no cost. Repairs and replacement parts are warranted for the remaining portion of the original warranty period.

Limited warranty on electric motors - 12 months

In keeping with the manufacturer's warranty, Chamberlain offer a 12 month warranty on all electric motors from the date of purchase. We will furnish a replacement motor free of charge, if it is found to be defective. Labour costs may apply.

Where the Unit has been installed by an authorised installer, Chamberlain will furnish replacement parts free of charge through the authorised installer. Warranty is based on the electric motor/operator being used in conjunction with controls supplied (or other controls authorised in writing prior to installation) by Chamberlain.

In-warranty service

During the warranty period, if the product appears as though it may be defective, call our technical department before removal of the unit. A Chamberlain technician will diagnose the problem and promptly supply you with the parts for "do-it-yourself" repairs, or provide you with shipping instructions for a factory repair or replacement.

If our service centre determines that a warranty claim has been made in respect of a failure or defect arising under or out of any exclusion set out below, we may charge you a fee to repair and/or return the unit to you.

Exclusions

This warranty does not cover any failure of the Unit due to:

1. non-compliance with the instructions regarding installation, operation, maintenance and testing of the Unit or of any product with which the Unit is used.
2. any attempt to repair, dismantle, reinstall or move the Product to another location once the Product is installed by any person other than an authorised installer.
3. tampering, neglect, abuse, wear and tear, accident, electrical storm (force majeure), excessive use or conditions other than normal commercial use.

This warranty does not cover any problems with, or relating to, the commercial door or door hardware, including but not limited to the door slats, door springs, door drum, door alignment or hinges, any problems caused by electrical faults or labour charges for reinstalling a repaired or replaced Unit.

Liability – Australia only

Under no circumstances shall the Seller be liable for consequential, incidental or special damages arising in connection with the use, or inability to use, the Unit. In no event shall the Seller's liability for damages or injury arising from breach of law or contract or for negligence, exceed the cost of repairing or replacing the Unit or refunding the purchase price of the Unit.

Under Division 2 Part V of the *Trade Practices Act, 1974*, certain warranties and conditions (**Implied Terms**) are implied into contracts for the supply of goods or services if the goods or services are of a kind ordinarily acquired for personal, domestic or household use or consumption. Liability for breach of those Implied Terms cannot be excluded or limited and the limitations and exclusions above do not apply to the Implied Terms.

Except for the Implied Terms and the warranties set out above, the Seller excludes all warranties and conditions implied by statute, at law, in fact or otherwise.

Liability – New Zealand only

Except as set out in the *Fair Trading Act 1986* and the *Consumer Guarantees Act 1993*:

- (a) all other guarantees, warranties and representations in relation to the Unit or its supply are excluded to the extent that the Seller can lawfully exclude them; and
- (b) under no circumstances shall the Seller be liable for consequential, incidental or special damages arising in connection with the use, or inability to use, the Unit, other than those which were reasonably foreseeable as liable to result from the failure.

Chamberlain reserves the right to change the design and specification without prior notification. Some features or accessories may not be available in certain markets or areas.

Australia
Phone toll free 1800 GRIFCO (474 326)

New Zealand
Phone toll free 0800 653 667